

**True Low Air Loss Therapy Blower
Replacement Mattress System**

Future Air True Low Air Loss
Instruction Manual



99 Seaview Boulevard
Port Washington, NY 11050
Phone: 516-998-4600
Fax: 516-998-4601
Toll Free: 877-224-0946
www.drivemedical.com#

Please Read Manual Before Operating Device.

Model No.: 14000 PLEASE READ ALL INSTRUCTIONS BEFORE USE.

CONTENTS

IMPORTANT SAFEGUARDS	2
1. INTRODUCTION	3
1.1 GENERAL INFORMATION	3
1.2 INTENDED USE	3
2. PRODUCT DESCRIPTION	4
2.1 BLOWER& MATTRESS SYSTEM	4
2.2 BLOWER UNIT	5
2.3 FRONT PANEL	5
3.INSTALLATION	7
3.1 BLOWER& MATTRESS INSTALLATION	7
4. OPERATION	9
4.1GENERALOPERATION	9
4.2 CPR	9
4.3 PRESSURE SET UP	10
4.4 AUDIBLE AND VISIBLE ALARM	10
4.5 ALARM MUTE	10
5. CLEANING	10
6. STORAGE	11
7. MAINTENANCE	11
7.1GENERAL	11
7.2 FUSE REPLACEMENT	11
7.3 AIR FILTER REPLACEMENT	12
7.4 RECHARGEABLE BATTERY	12
8. TROUBLESHOOTING	12
9. TECHNICAL DESCRIPTION	13
SAVE THESE INSTRUCTIONS	14

SAVE THESE INSTRUCTIONS GROUNDING INSTRUCTIONS

This product should be grounded. In the event of an electrical short circuit grounding reduces the risk of electric shock by providing an escape wire for the electric current. This product is equipped with a cord having a grounding wire with a grounding plug. The plug must be plugged into an outlet that is properly installed and grounded.

DANGER-Improper use of the grounding plug can result in a risk of electric shock.

If repair or replacement of the cord or plug is necessary, do not connect the grounding wire to either flat blade terminal. The wire with insulation having an outer surface that is green with or without yellowstripes is the grounding wire.

NOTE-If the repair or replacement of the cord is necessary, please contact aqualified electrician or serviceman. To reduce the risk of electric shock, do not modify the cord or plug in any way.

Check with a qualified electrician or serviceman if the grounding instructions are not completely understood, or if in doubt as to whether the product is properly grounded.

1 YEAR LIMITED WARRANTY

Your Drive brand product is warranted to be free of defects in materials and workmanship for one year of the original consumer purchaser.

This device was built to exacting standards and carefully inspected prior to shipment. This 1 year Limited Warranty is an expression of our confidence in the materials and workmanship of our products and our assurance to the consumer of years of dependable service.

This warranty does not cover device failure due to owner misuse or negligence, or normal wear and tear. The warranty does not extend to non-durable components which are subject to normal wear and need periodic replacement.

If you have a question about your Drive device or this warranty, please contact an authorized Drive dealer.

9. TECHNICAL DESCRIPTION

Specifications:

Item		Specification	
Power Supply(Note: See rating label on the product)		AC 100-120V 50/60 Hz, 5.0A (for 120V system) AC 220-240V 50/60 Hz, 3A(for 230V system)	
Fuse Rating		T5A/250V(for 120V system) T3A /250V(for 230V system)	
Dimension(LxWxH)		15.8 x 38 x 26.8 (cm) or 6.2" x 15" x 10.5"	
Weight		5.5 kg or 12.1 lb	
Environment	Temperature	Operation:10° C to 33° C (50° F to 91° F) Storage: -15° C to 50° C (5° F to 122° F) Shipping: -15° C to 70° C (5° F to 158° F)	
	Humidity	Operation: 10% to 90% non-condensing Storage: 10% to 90% non-condensing Shipping:10 % to 90% non-condensing	
Classification		Class I, Type BF, IPX0 Applied Part: Air Mattress Not suitable for use in the presence of a flammable anesthetic mixture (No AP or APG protection)	
Mattress		Specification	
Model		8" Mattress with 10" side bolster 2" foam pocket is provided	
		Standard (35.4" width)	48" width
Dimension (LxWxH)		200 x 90 x 20.3 (25.4) cm or 78.7" x 35.4" x 8" (10")	200 x 122 x 20.3 (25.4) cm or 78.7" x 48" x 8" (10")
Weight		7.5 kg or 16.5 lb	9.5 kg or 20.9 lb
Maximum Weight Capacity		200kg or 440 lbs	450kg or 1,000lbs

 **NOTE:**Mattress dimension and weight is measured without foam cushion

DANGER - To reduce the risk of electrocution:

1. Always unplug this product immediately after using.
2. Do not use while bathing.
3. Do not place or store product where it can fall or be pulled into a tub or sink.
4. Do not place in or drop into water or other liquid.
5. Do not reach for a product that has fallen into water. Unplug immediately.

WARNING - To reduce the risk of burns, electrocution, fire, or injury to persons:

1. This product should never be left unattended when plugged in.
2. Close supervision is necessary when this product is used by, on, or near children or invalids.
3. Use this product only for its intended use as described in this manual. Do not use attachments not recommended by the manufacturer.
4. Never operate this product if it has a damaged cord or plug, if it is not working properly, if it has been dropped or damaged, or dropped into water. Return the product to a service center for examination and repair.
5. Keep the cord away from heated surfaces.
6. Never block the air openings of this product or place it on a soft surface, such as a bed or couch, where their openings may be blocked. Keep the air opening free of lint, hair, and other similar particles.
7. Never drop or insert any object into any opening or hose.
8. Connect this product to a properly grounded outlet only. See Grounding Instructions.

NOTE, CAUTION AND WARNING STATEMENTS:

NOTE - Indicate some tips.

CAUTION - Indicate correct operating or maintenance procedures in order to prevent damage to or destruction of the equipment or other property.

WARNING - Calls attention to a potential danger that requires correct procedures or practices in order to prevent personal injury.

SYMBOLS

 EC REP Authorised representative in the European community

 Manufacturer

 "BF"symbol, indicate this product is according to the degree of protecting against electric shock for type BF equipment

 Grounding terminal (for 230V system)

 Attention, should read the instructions!

 Disposal of Electrical & Electronic Equipment (WEEE):
This product should be handed over to an applicable collection point for the recycling of electrical and electronic equipment. For more detailed information about the recycling of this product, please contact your local city office, household waste disposal service or the retail store where you purchased this product.

This manual should be used for initial set up of the system and for reference purposes.

1.1 GENERAL INFORMATION

The system is a true low-air-loss mattress system suitable for prevention and treatment of Pressure Ulcers up through Stage IV.

The system has been tested and successfully approved with the following standards:

- EN 60601-1
- EN 60601-1-2
- EN 55011 Class B
- IEC61000-3-2
- IEC 61000-3-3

 **FOR US AND CANADA ONLY**

 Medical Equipment-Air Blower
 E228589 with respect to electrical shock, fire and
 53DG mechanical hazards only in accordance with
 UL60601-1 AND CAN/CSA C22.2 NO.601.1

Le produit à été testé avec des équipements médicaux et respecte les normes UL 60601-1 & CAN/CSA C22.2 No.601.1. prévenant les choc électrique, le feu et les risques de blessures physiques.

1.2 INTENDED USE

This product is intended to help treat and reduce the incidence of pressure ulcers from Stage I – Stage IV, while optimizing patient comfort. It is appropriate for use in home care, long term care and acute care settings.

 **NOTE:**Equipment not suitable for use in the presence of a flammable anesthetic mixture with air or with oxygen or nitrous oxide.

 **NOTE:**L'équipement ne peut être utilisé s'il y a risque de mélange d'un anesthésique inflammable avec l'air ou l'oxygène ou oxyde nitreux.

2. PRODUCT DESCRIPTION

7.3 AIR FILTER REPLACEMENT

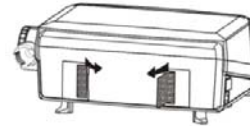

1. Replace the air filter located at the bottom of blower.
2. The filter is reusable and can be washed gently with a mild detergent and water. Dry the filter before use.
3. Check and replace air filter regularly if environment is dirty.

7.4 RECHARGEABLE BATTERY

1. To check if the rechargeable battery has been drained out, unplug the power cord and see if the Power Failure indicator will light up along with buzzer last for a few minutes.
2. If the Power Failure Alarm is unable to work or the battery might need to be replaced (approximate life expectancy 6 months), user can contact your dealer or notify the technician for replacement.

8. TROUBLESHOOTING

Problem	Solution
Power is not ON	<ul style="list-style-type: none"> • Check if the plug is connected to mains. • Check if there is any blown fuse.
Alarm is on (Audible & visual)	<ul style="list-style-type: none"> • Check if the Quick Connector is rotated to the Lock/on position. • Check if the power is suddenly shut down. • Check if the connection between air tube connector to blower unit is tightly secured. • Check if all tubing connections along mattress are secured.
Patient is bottoming out	<ul style="list-style-type: none"> • Pressure setting might be inadequate for the patient, adjust comfort range 1 to 2 levels higher and wait for a few minutes for best comfort.
Automatic fowler boost is not functioning	<ul style="list-style-type: none"> • Check if the fowler boost adaptor is connected and secured to the blower unit. • Check if the fowler boost sensor pad tightly snapped to the designated location inside the bottom of the mattress foam pocket.

If the above information does not solve your problems, please contact your local agent directly. They might require a technician to take care of the problem.

2.1 BLOWER AND MATTRESS SYSTEM

By wiping the mattress unit with a damp cloth pre-soaked with warm water (not to exceed 65 °C) containing a mild detergent, and keep it away from dust. The cover may also be cleaned using sodium hypochlorite diluted in water. All parts should be air dried thoroughly before use.

CAUTION: Do not use phenolic-based product for cleaning.

CAUTION: After cleaning, dry the mattress without direct exposure of sunlight.

The carrying bag (if available) should be turned inside out and completely wiped down using the disinfectant solutions. Allow it to air-dry thoroughly. Once the inside is dry, turn it back and wipe down the outside of the bag with disinfectant solutions.

6. STORAGE

1. To quickly vacuum air out from mattress for storage, rotate the Quick Connector to the CPR position and press the "Max Firm" button. It will vacuum air out within 5 minutes and then blower will stop automatically.
2. Disconnect the automatic fowler boost adaptor on the side of the blower unit.
3. Rotate Quick Connector to the "Disconnect" position and pull up the Quick Connector.
4. Lay the mattress out flat and upside down.
5. Roll from the head end towards the foot end.
6. Foot-end strap can then be stretched around the rolled mattress to prevent unrolling.
7. The power cord could be wrapped around the blower bumper on the back of blower.

CAUTION: When the blower is vacuuming air, air temperature is hot. Do not block the air outlet.

NOTE: Do not fold, crease or stack the mattresses.

7. MAINTENANCE

7.1 GENERAL

1. Check main power cord and plug, and auto fowler boost cord if there are abrasions or excessive wears.
2. Check mattress cover for signs of wear or damage. Ensure mattress cover and tubes are stubbed together correctly.
3. Check the air hoses for any kink or break. For replacement, please contact your local dealers.

7.2 FUSE REPLACEMENT

1. Quick Connector
 2. Blower Unit
 3. Differential Zone Mattress
 4. Auto Fowler Boost Sensor Pad (for standard 35.4" mattress only)
 5. Mattress Foam Pocket
1. Disconnect the plug from mains power when a blown fuse is suspected.
 2. Remove the cover of the fuse holder by means of a small screwdriver.
 3. Insert a new fuse of the correct rating in, and replace the cover of the fuse holder back. The fuse should be rated as 5A/250V (for 120V system) and T3A /250V (for 230V system) type.



2.2 BLOWER UNIT

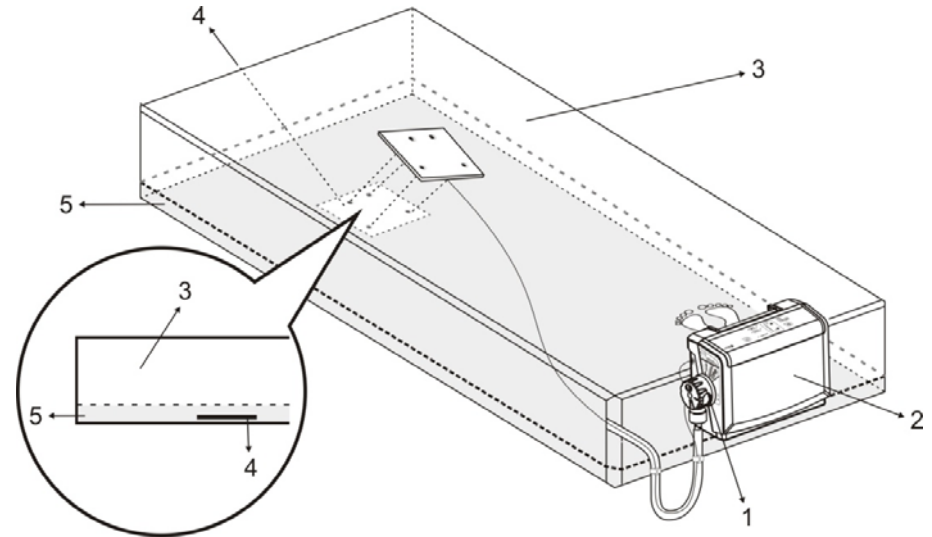

4.3 PRESSURE SET UP

Users can adjust pressure of air mattress to a desired softness by adjusting the Comfort Level. Please consult your physician by the below weight support range for a suitable setting.

NOTE:Maximum Weight Capacity : 200kg or 440 lbs (for 35.4" model)
450kg or 1,000lbs (for 48" model)

4.4 AUDIBLE AND VISIBLE ALARM

When the following situation occurred, the LED lights will light up along with the buzzer.

4.4.1 CPR – When CPR or quick storage is performed, or the Quick Connector is on Disconnect position under power on situation, the “CPR” indicator (orange LED) will light up along with buzzer.

4.4.2 Power Failure – When electrical shortage occurred or power cord is disconnected without turning off the blower first, the “power failure” indicator (orange LED) will light up along with buzzer. Check to ensure power cord is connected properly.

4.4.3 Low pressure – When an abnormal low pressure occurred in body section, the “Low Pressure” indicator (orange LED) will light up along with buzzer. Check all tubings are correctly installed as per installation instructions and ensure all tubings are secured properly. The Low Pressure indicator will continuously light up until the low-pressure fault condition is resolved.

4.5 ALARM MUTE

When these situations mentioned above occurred, both the LED light and buzzer will sound off to warn the patient. By pressing the button, it will temporary mute the buzzer (CPR & Low Pressure) so the caregiver may check for possible causes. Should the CPR & low pressure situation not resolved within 3 minutes, the alarm will resume to beep. When in Power Failure situation, pressing alarm mute button, it will cease the buzzer and turn off the “power failure” indicator.

5. CLEANING

By wiping the blower unit with a damp cloth pre-soaked with a mild detergent, and keep it away from dust. If other detergent is used, choose one that will have no chemical effects on the surface of the plastic case of the blower unit.

CAUTION: The Fowler Boost Sensor Pad should be always kept away from water.

CAUTION: Do not immerse or soak blower unit.

2.3 FRONT PANEL

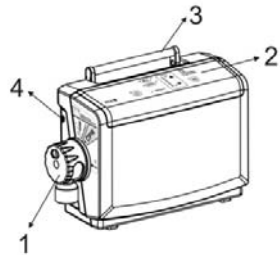

- Front
1. Quick Connector
 2. Front Panel
 3. Handle
 4. Auto Fowler Boost Adaptor

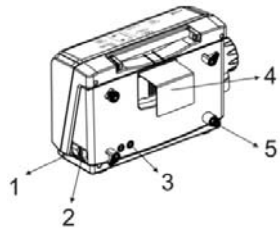

- Rear
1. Power Switch
 2. Power Socket
 3. Fuses
 4. Mounting Bracket
 5. Blower Bumper

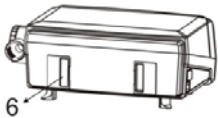

6. Air Filter

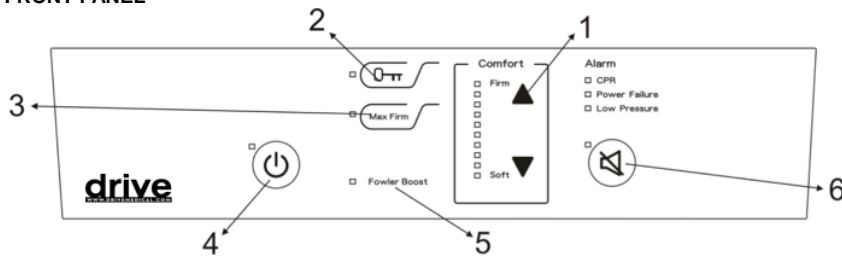

1. ComfortLevel
Comfortlevel controls the air pressure output. When turning up (▲), the output pressure will increase and higher pressure output will support the heavier weight user. Vice vers (▼) for decreasing air pressure.

NOTE:Maximum Weight Capacity : 200kg or 440 lbs (for 35.4" model)
450kg or 1,000lbs (for 48" model)

Grounding:

Before any connection to the output connectors is made, the unit shall be connected to a protective earth conductor via the three-core main cable; the mains plug shall be inserted only into a socket outlet provided with a protective earth contact. The protective action shall not be negated by the user of an extension cord without protective conductor.

Several installation tips are listed below:

After installation, the extra length of the power cord, if any, should be neatly arranged to avoid any tripping accidents. The EQUIPMENT should be firmly placed at position where users/doctors can access easily.

4. OPERATION

 **NOTE:** Always read the operating instruction before use.

4.1 GENERAL OPERATION



1. Switch on the main power switch found from the side of the blower and press  on the control panel to turn on the power.
2. The system will automatically go into “Max Firm” mode for a few minutes of inflation.

 **NOTE:** The mattress is equipped with differential zone feature, therefore center section of the mattress will be inflated quicker than the head and foot sections.

3. The low-pressure indicator (orange LED) will light up when the mattress is not fully inflated.
4. According to the weight and height of the patient, adjust the pressure setting to the most suitable level without bottoming out.

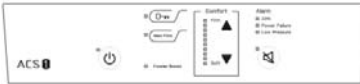

4.2 CPR

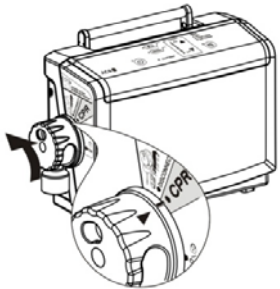

When CPR needs to be performed, quickly rotate the Quick Connector to the CPR position to release air.

2. Panel Lock

Should the panel remain untouched for 5 minutes, the panel lock feature will lock the panel with green LED light on to prevent accident from changing the setting during normal operation. To unlock, simply by pressing the Panel Lock button for 3 seconds.

3. Max Firm

This mode will be forced to execute every time the power is turned on. This insures the blower is able to reach its maximum operating pressure. Once the max pressure level is reached, the blower will automatically switch into the previous selected comfort level. User can also use this function as full mattress inflation during patient ingress/egress for better support. There is a 20 minutes auto-recovery mode to return back the previous selected comfort level.

4. On/off

Press On to turn on the unit. Press Off to turn off/standby the unit.

 **NOTE:** The power switch on the side of blower must be turned on.

5. Fowler Boost

The automatic Fowler Boost features additional supports to the patient during upright position to prevent bottoming out. This function is automatically activated when the bed is raised and deactivated when the bed is flat.

 **NOTE:** This function is only available for 35.4" replacement mattress system.

 **NOTE:** When the patient in the raised position, it is recommended that caregiver readjust the patient sitting posture to prevent possible bottoming out.

6. Alarm Mute

Press alarm mute button to temporary suspend the CPR and low-pressure alarm. Should the situation not resolved within 3 minutes, the alarm shall resume to notify the patient.

A. CPR

During the CPR situation, the caregiver can rotate the quick connector to perform CPR. Once the quick connector is switched to CPR mode, CPR alarm will sound with LED light on to notify the caregiver.

B. PFA (Power Failure Alarm)

During power failure situation, the Power Failure LED light will light on with buzzer. By pressing the mute button to disable both buzzer and LED.

C. Low Pressure Indicator

When low pressure LED continuously lights up with buzzer, the pressure inside of air mattress body section is abnormal, please check all tubings are correctly installed as per installation instructions and ensure all tubings are secured properly.

 **NOTE:** The low pressure indicator will not be detected if air cells of mattress are purposely disconnected.

3. INSTALLATION

Unpacking the box to inspect for any damage, which may have occurred during shipment. If there are any damages, please contact your dealer immediately.

3.1 BLOWER & MATTRESS INSTALLATION

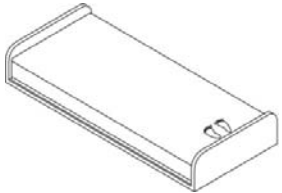

1. Place the mattress on top of the bed frame. Please note for the foot end.

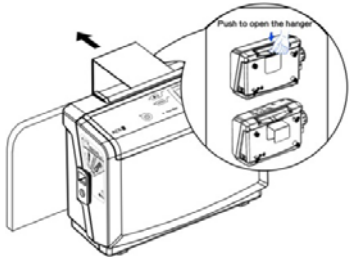

2. Hang the blower onto bed rail (foot-end), and adjust hangers to best upright position of the blower.

NOTE: Do not place the blower on flat surface, this might block the air intake of blower unit.

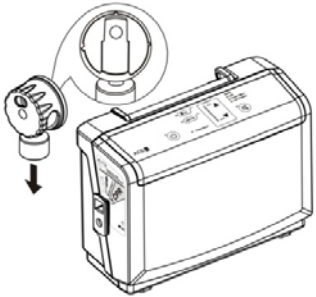

3. Connect air hose connectors from air mattress to the blower unit. Make sure the connector is in the right position as the inserted diagram below. Rotate the connector clockwise to the Lock / on position. When a "click" sound is felt or heard, the connection is completed and secured.

NOTE: The blower is only operable at "Lock/On" position.

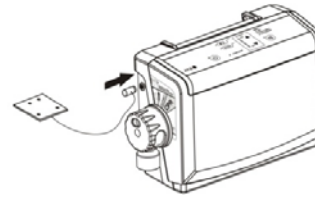
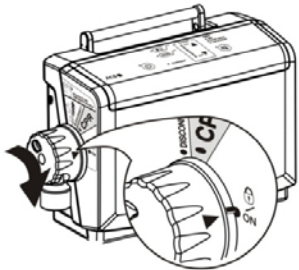

4. Connect and secure the automatic fowler boost adaptor on the side of the blower unit. The automatic fowler boost sensor pad must snap to the designated location inside the bottom of the mattress foam pocket.

NOTE: This function is only available for 35.4" replacement mattress system.

NOTE: Use the Velcro strips to fasten the cable of fowler boost sensor pad to prevent stumbling.

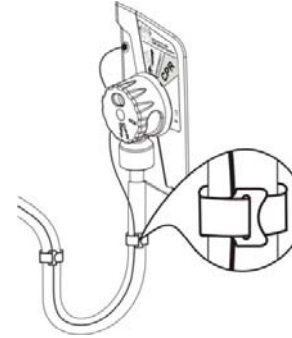

5. Plug the power cord into electrical outlet.

NOTE: 1. Make sure the blower unit is suitable for the local power voltage.
2. The plug is also served to disconnect the device.

CAUTION: The blower can only be applied to the mattress recommended by the manufacturer. Do not use it for any other purpose. (applied part: air mattress)

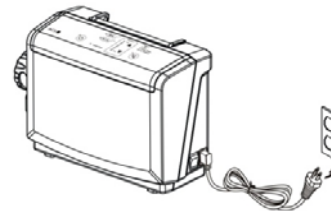

6. Then turn the main power switch to ON position.